

Options Available:-

Part No.	Length	Material	Finish
56420	9"	Stainless Steel 304	Brushed Stainless
56422	12"	Stainless Steel 304	Brushed Stainless
56426	18"	Stainless Steel 304	Brushed Stainless
56428	24"	Stainless Steel 304	Brushed Stainless
56432	48"	Stainless Steel 304	Brushed Stainless

Product Dimensions:-

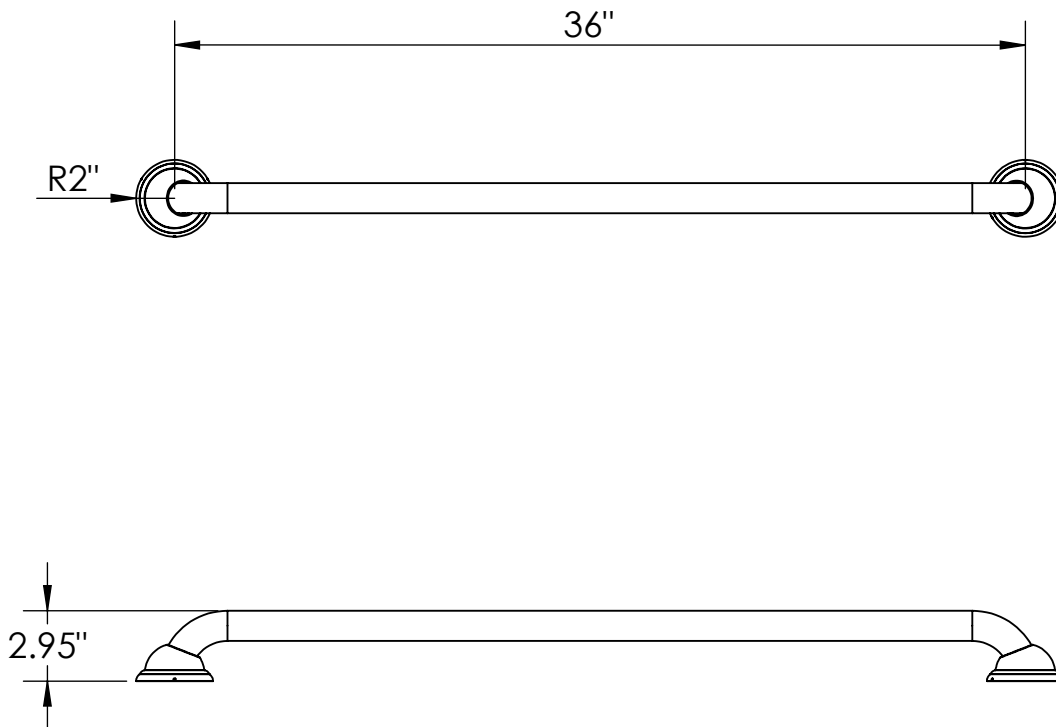

Copyright © 2017 Krome USA Inc. All Rights Reserved



US & Canada :- +1-678 666 2001

Asia:- +91-9814203010

Krome USA Inc. reserves the right to make revisions to product specifications without any notice

For most updated specification sheet , go to www.aluids.com