

PART NO.-

C8453 Line Drawing

TITLE-

Double Pantry Wall Mount Swivel Base Faucet with 8" Swing Nozzle

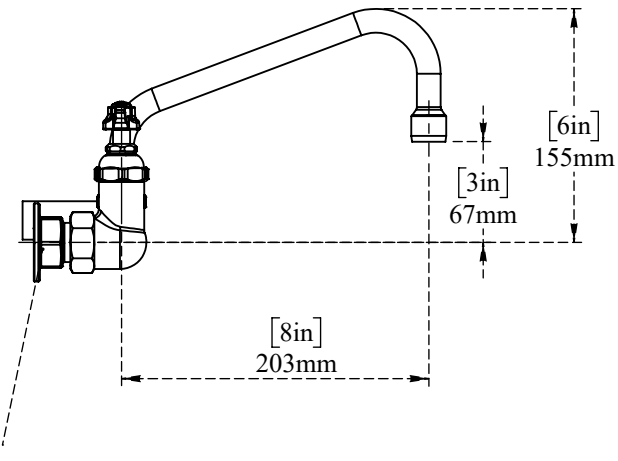
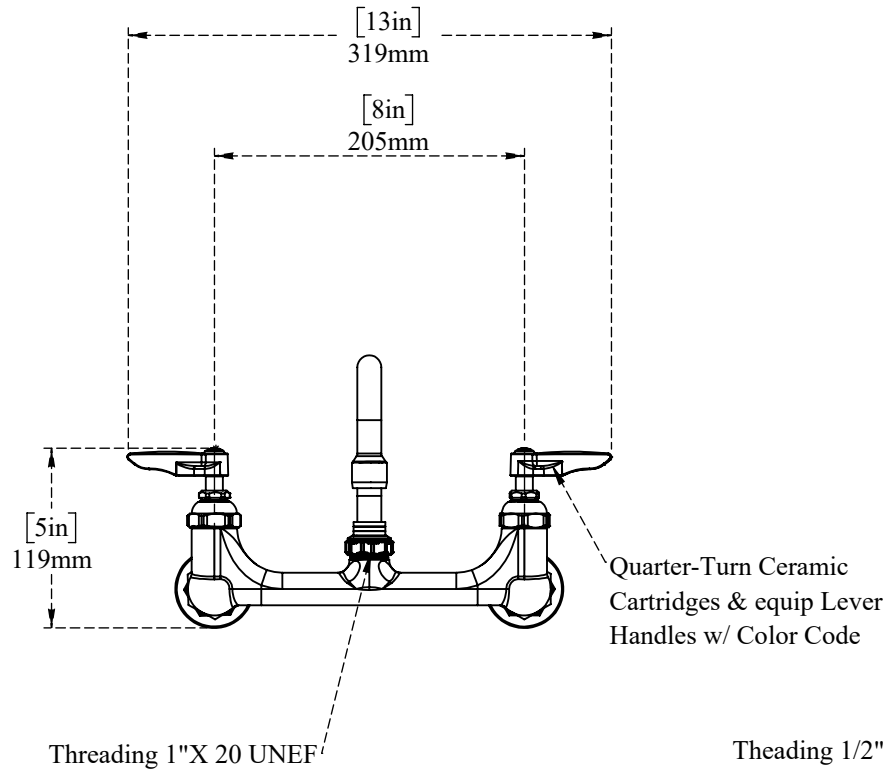
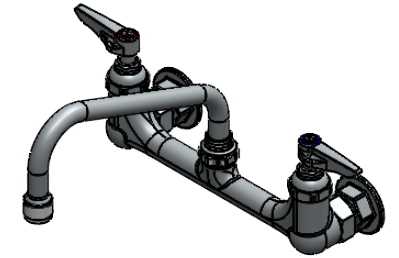

ALUIDS

Note:- Information provided for reference only.

* This document and the information thereon is the property of Krome Dispense Pvt Ltd. &its subsidiaries. Any reproduction in part or as a whole without the written permission of Krome Dispense Pvt Ltd. is prohibited.